

A piano / top / plan / Platte

TIPOLOGIE:

filopiano lavabo integrato;
per lavabo sopra piano da appoggio e
da incasso e sottopiano da incasso
PROFONDITA': 45-51,5 cm
FINITURE: Arock® - HPL - Nobilitato
LEGNO/ALTATTO - Laccato OPACO/
LUCIDO - GRES - PIETRA NATURALE -
SILESTONE - CRISTALLO

TYPES:

integrated plan washbasin;
for countertop basin, recessed basin
and undermounted basin
DEPTH: 45-51.5 cm
FINISHES: Arock® - HPL - Nobilitato
LEGNO/ALTATTO - Laquered MATT/
GLOSSY - GRES - NATURAL STONE -
SILESTONE

TYPOLOGIES:

lavabo intégré au plan;
pour lavabo à poser, lavabo encastré
surélevé et lavabo encastré
PROFONDEUR: 45-51,5 cm
FINITIONS: Arock® - HPL - Mé laminé
BOIS/ALTATTO - Laque MAT/BRIL-
LANT - GRES - PIERRE NATURELLE
- SILESTONE

TYPOLOGIEN:

integriertes Waschbecken;
für Aufsatzwaschtisch, Halbeinbau-
becken und Einbauwaschtisch
TIEFE: 45-51,5 cm
AUSFÜHRUNGEN: Arock® - HPL -
Melamin HOL /ALTATTO - MATT/
HOCHGLANZ Lack - GRES - NATUR-
STEIN - SILESTONE

B contenitore / interior configuration / configuration intérieure / Innenausstattung

realizzato in pannelli di particelle di
legno di spessore 16 mm, idrofughi,
nobilitato con carta melaminica colore
URBAN. Bordi in ABS in tinta.
Cassetto montato su guide GRASS®
ad estrazione totale con sponde
laterali in metallo verniciato colore
URBAN. Fondo e schienale nella
finitura del contenitore
ALTEZZA : 37-55,5 cm
PROFONDITA': 45-51,5 cm
LARGHEZZA: 27-36-54-63-72-81-
90-108 cm

made of water repellent panels of 16
mm thick wood particles, covered
with Nobilitato URBAN color.
Matching ABS edges
Drawer mounted on full extension
GRASS® runners with URBAN color
painted metal sides. Bottom and back
in the finish of the container
HEIGHT: 37-55,5-74 cm
DEPTH: 45-51,5 cm
WIDTH: 27-36-54-63-72-81-90-
108 cm

en panneaux hydrofuges en particules
de bois de 16 mm d'épaisseur. Re-
couvert de papier mélaminé couleur
URBAN. Bords ABS de la même
couleur
Tiroir monté sur coulisses GRASS®
pleine extension avec côtés en métal
peint couleur URBAN. Fond et retour
dans la finition du intérieur
HAUTEUR: 37-55,5-74 cm
PROFONDEUR: 45-51,5 cm
LARGEUR: 27-36-54-63-72-81-90-
108 cm

in wasserabweisenden Platten aus
16 mm starken Holzpartikeln. Farb-
melaminpapier und ABS Kanten der
gleichen Farbe
Schublade montiert auf GRASS®
Vollauszügen mit URBAN-farbig
lackierten Metallseiten. Boden und
Rückseite im Abgang des Behälters
HÖHE: 37-55,5-74 cm
TIEFE: 45-51,5 cm
BREITE: 27-36-54-63-72-81-90-108
cm

C frontali / front panels / tiroirs / Schublade

realizzato in pannelli di particelle di
legno idrofugo nobilitato con carta
melaminica
SPESSORE: 1,8 cm
FINITURE: Laccato OPACO/LUCIDO 48
colori.02 - Nobilitato LEGNO/ALTATTO

made of water repellent panels of
wood particles
THICKNESS: 1,8 cm
FINISHES: MATT/GLOSSY Lacquered
48 colori.02 - Nobilitato LEGNO/
ALTATTO

en panneaux hydrofuges en particules
de bois recouvert de papier mélaminé
ÉPAISSEUR: 1,8 cm
FINITIONS: Laqué MAT/BRILLANT
en 48 colori.02 - Nobilitato LEGNO/
ALTATTO

aus wasserabweisenden Spanplatten,
veredelt mit Melaminpapier
DICKE: 1,8 cm
OBERFLÄCHEN: MATT/HOCHGLANZ
Lack aus 48 colori.02 - Nobilitato
LEGNO/ALTATTO

D apertura / opening system / système d'ouverture / Öffnungssystem

fascia maniglia in alluminio verniciato

painted alu. handle-profile

profil poignée en aluminium laqué

Griffprofil aus lackiertem Aluminium

E pannelli terminali / terminal panles / panneaux lateraux / seitliche Panele

OBBLIGATORI

realizzati in pannelli di particelle di
legno
SPESSORE: 1 cm
FINITURE: Laccato OPACO/LUCIDO
in 48 colori.02 - Nobilitato LEGNO/
ALTATTO

REQUIRED

made of water repellent panels of
wood particles
THICKNESS: 1 cm
FINISHES: MATT/GLOSSY Lacquered
48 colori.02 - Nobilitato LEGNO/
ALTATTO

OBLIGATOIRE

panneaux hydrofuges en particules
de bois
ÉPAISSEUR: 1 cm
FINITIONS: Laqué MAT/BRILLANT
en 48 colori.02 - Nobilitato LEGNO/
ALTATTO

WICHTIG

aus wasserabweisenden Spanplatten,
veredelt mit Melaminpapier
DICKE: 1 cm
OBERFLÄCHEN: MATT/HOCHGLANZ
Lack aus 48 colori.02 - Nobilitato
LEGNO/ALTATTO

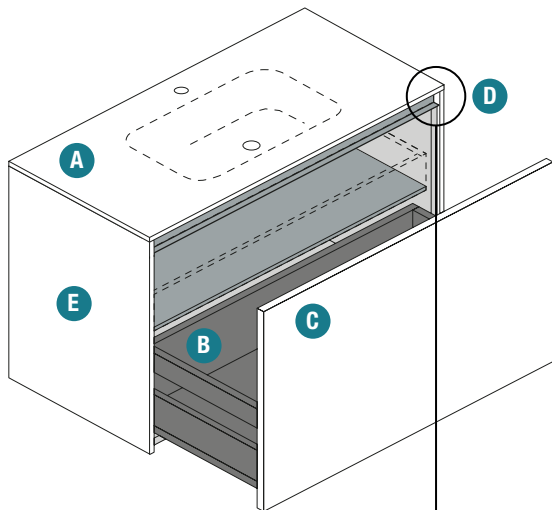

frontale unico estraibile
 single drawer
 meuble avec un tiroir
 Möbel mit ein Schublade

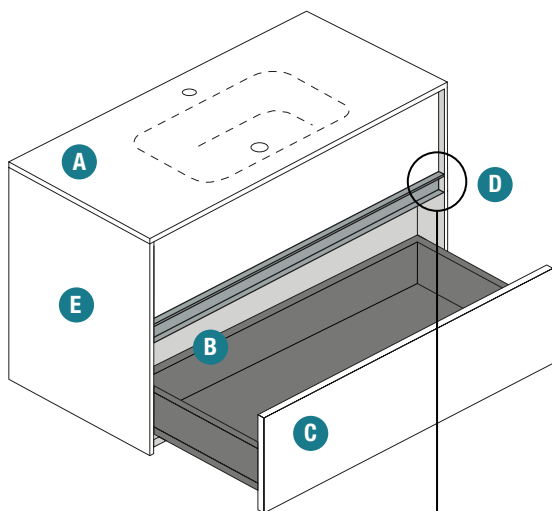
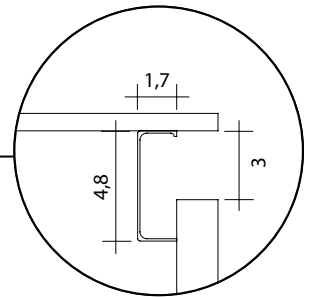

doppio frontale estraibile
 double drawer
 meuble avec deux tiroirs
 Möbel mit zwei Schubladen

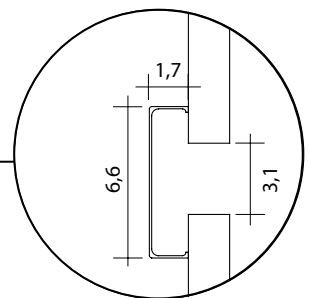

Nobilitato LEGNO

pannello di particelle di legno spessore 18 mm idrofugo a basso contenuto di formaldeide nobilitato interno ed esterno con carta melaminica in finitura LEGNO riprodotto ad alta fedeltà; bordo in ABS in finitura

high pressure layered laminate, a perfect and strong imitation of the natural wooden surface

stratifiés décoratifs haute pression. Plaques à base de résines thermosensibles appelées stratifiés

Hochdruckmehrschichtlaminat mit einer dreidimensionalen Erscheinung

**Nobilitato ALTATTO****laccato OPACO / LUCIDO
MATT / GLOSSY lacquered**

pannello di particelle di legno, idrofugo, a basso contenuto di formaldeide, verniciato con resine poliuretaniche pigmentate opache o lucide

wood particles panel 18 mm with low formaldehyde content, painted with polyurethane resins

**laqué MAT / BRILLANT
MATT / HOCHGLANZ lackiert**

panneaux de particules de bois 18 mm à faible teneur en formaldéhyde, peint avec des résines de polyuréthane

Holzpartikelplatte 18 mm mit niedrigem Formaldehydgehalt, mit Polyurethanharzen lackiert





Fascia maniglia

FINITURE incluse nel prezzo
 . laccato OPACO 48 **colori.02**

FINITURE a richiesta + euro 55

. 61 Orosatinato . 21 Tinox®
 . 62 Ororosa . 22 Tbronz®
 . 63 Cromonero

Handle profile

FINISHES (incl. in the price)
 . MATT lacquered 48 **colori.02**

FINISHES (on demand) + euro 55

. 61 Orosatinato . 21 Tinox®
 . 62 Ororosa . 22 Tbronz®
 . 63 Cromonero

Profil poignée

FINITIONS (incl. dans le prix)
 . laqué MAT 48 **colori.02**

FINITIONS (sur demande) + euro 55

. 61 Orosatinato . 21 Tinox®
 . 62 Ororosa . 22 Tbronz®
 . 63 Cromonero

Griffprofil

OBERFLÄCHEN (inkl. im Preis)
 . MATT lackiert 48 **colori.02**

OBERFLÄCHEN (auf Anfrage) + euro 55

. 61 Orosatinato . 21 Tinox®
 . 62 Ororosa . 22 Tbronz®
 . 63 Cromonero

abbinamento consigliato mobile/maniglia combinations furniture/handle

coordinations meuble/poignée Griffabstimmung

mobile Nobilitato LEGNO

	12W ABETE BIANCO	▶
	14W ABETE BROWN	▶
	26W ABETE ROCCIA	▶
	27W ABETE FONDATE	▶
	31W FRONDA PURO	▶
	32W FRONDA LIEVE	▶
	33W FRONDA NUDO	▶
	34W FRONDA ARCANO	▶

maniglia laccato OPACO

	01 NUDE	▶
	0H CURCUMA	▶
	05 WILD	▶
	0U MOCHA	▶
	01 NUDE	▶
	0G EARTH	▶
	03 NATURE	▶
	59 NERO	▶

	01I ALTATTO LUNARE	▶
	02I ALTATTO BIOTITE	▶
	03I ALTATTO GENESI	▶
	04I ALTATTO MARKINA	▶

	13 ELEGANT GREY	▶
	0U MOCHA	▶
	16 DEEP GREY	▶
	40 URBAN	▶

i colori qui riportati sono da considerarsi indicativi
 the colours can diverge from the reality
 la fidélité des couleurs peut être différent de la réalité
 bitte berücksichtigen Sie unsere Farbfächer zur Farbauswahl

UNICAMENTE

AROCK®

ALCENTIMETRO

PROGETTO

piani / tops / plans / Platten

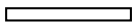

piano e piano d'arredo
top for interior
plan pour l'ameublement
Platte fuer Einrichtung

piano e piano d'arredo accoppiato
coated
accouplé
verdoppelt

lavabo / basin / vasque / Becken

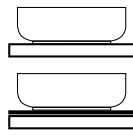

soprapiano da appoggio
countertop basin
lavabo à poser
Aufsetzbecken

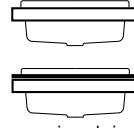

soprapiano da incasso
recessed basin
lavabo encastré surélevé
Halbeinbaubecken



sottopiano da incasso
undermounted basin
lavabo en profondeur
Unteneinbaubecken



lavabo integrato
integrated basin
vasque intégrée
integriertes Becken

	SP cm	P 45 cm	P 51,5 cm	
AROCK®	1,2 / 6			
Laccato OPACO / LUCIDO	1,8			
Nobilitato LEGNO / ALTATTO	1,8			
Nobilitato LEGNO / ALTATTO + GRES Laccato OPACO / LUCIDO + GRES	2,4			
HPL	1			
GRES	0,6 / 1,2			
	1,2			
CRISTALLO extrachiaro verniciato extra-clear lacquered GLASS VERRE lacquée extraclair Hochglanz lackierte GLAS	1,2			
PIETRA NATURALE NATURAL STONE PIERRE NATURELLE NATURSTEIN	2			
SILESTONE	1,2			

Modularità
Modularity

Modularité
Modularität

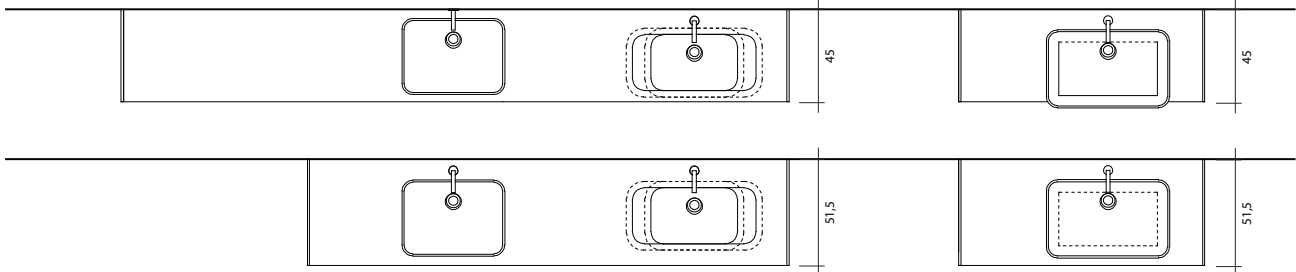
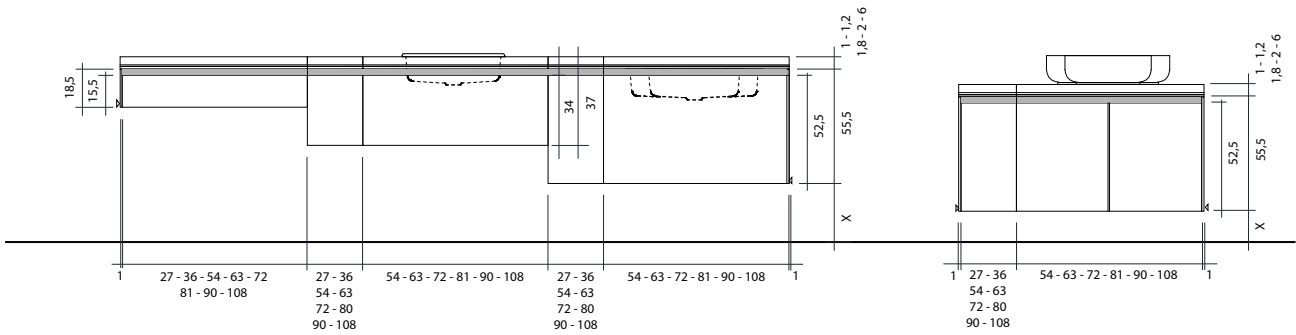
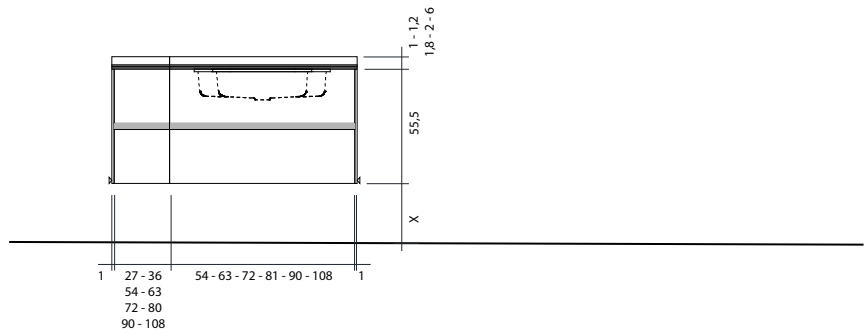

basi portalavabo
vanity units
meubles sous-vasque
Waschtischunterschänke

L 54-63-72-81-90-108 cm

basi laterali
side units
meubles bas latéraux
Unterschänke

L 27-36-54-63-72-81-90-108 cm

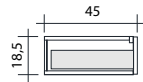

frontale unico estraibile con cassetto, chiusura ammortizzata
 single pull-out, soft-closing
 façade amovible avec tiroir
 1 Schublade

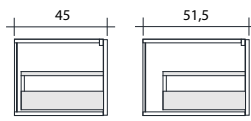
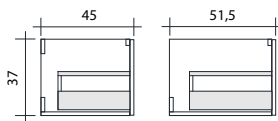

frontale unico estraibile con cassetto, chiusura ammortizzata
 single pull-out, soft-closing
 façade amovible avec tiroir
 1 Schublade

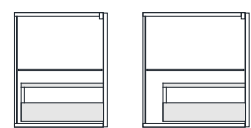
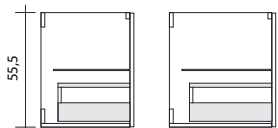

frontale unico estraibile con cassetto chiusura ammortizzata + 1 ripiano
 single pull-out, soft-closing + 1 shelf
 façade amovible avec tiroir + 1 étagère
 1 Schublade + 1 Regal

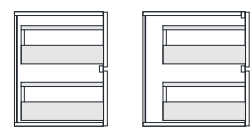
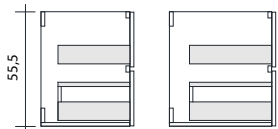

doppio frontale estraibile con cassetto, chiusura ammortizzata
 2 removable fronts with drawer
 2 façades amovible avec tiroir
 2 Schublade

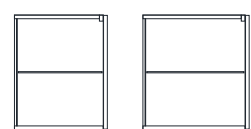
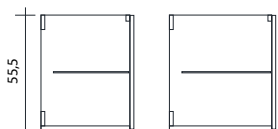

1 anta o 2 ante chiusura ammortizzata + 1 ripiano
 single door or double door, soft-closing + 1 shelf
 1 porte ou 2 portes + 1 étagère
 1 Tür oder 2 Türen + 1 Regal