





sistema di supporti abbinabili per combinazioni angolari  
cerniere per deflettore Bella con rotazione 180°

*combinable supports for corner installations  
Bella hinges 180° opening and screws fixing*





supporto di rinforzo fisso  
profilo a terra in finitura

*fixed support  
in ground profile finish*

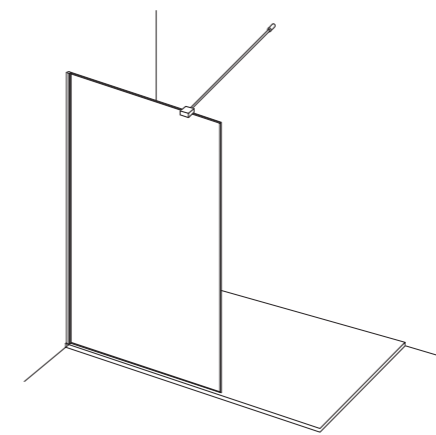

Walk-in installazione laterale  
*Walk-in side installation*

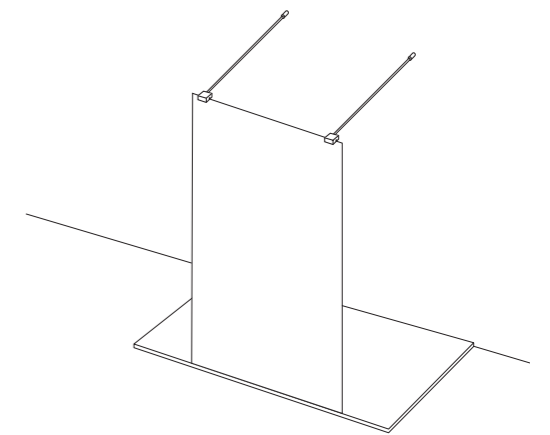

Walk-in installazione centrale  
*Walk-in central installation*



### CARATTERISTICHE FEATURES

**H**  
cm ALTEZZA PARETI DOCCIA 200/225  
SHOWER DOOR HEIGHT 200/225

**SP**  
mm SPESSORE LASTRA 6/8/10  
GLASS DEPTH 6/8/10

**REV**  
REVERSIBILE  
REVERSIBLE

### INFO TECNICHE TECHNICAL INFORMATION

**1**  
REGOLAZIONE FUORI SQUADRO  
OFF-SQUARE REGULATION

**1 cm**  
ESTENSIBILITÀ  
EXSTENSIBILITY

**NEVERDROP®**  
TRATTAMENTO NEVERDROP®  
NEVERDROP® TREATMENT

**L/H**  
MISURE SPECIALI  
SPECIAL SIZES

### Finiture profili

#### COLORE



20 RAL9010  
Colori/  
Tcrom®  
59/60  
Nero/Bianco  
Totale

### Profiles finishing

#### ABITAT



27 Tcrom®  
21 Tinox®  
22 Tbronz®

#### VOGUE



61 Orosatinato  
62 Ororosa  
63 Cromonero  
Colori  
Totale

### Vetri



30 Trasparente  
29 Fumè

### Glasses

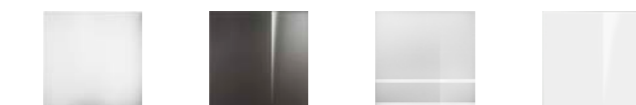

16 Satinato  
12 Reflex  
11 Flack  
31 Extrachiaro

### Decografia



0A/1A Optical nero  
Trasparente/Fumè  
0B/1B Optical bianco  
Trasparente/Fumè

### Decoprinting

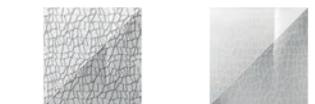

0E/1E Terra nero  
Trasparente/Fumè  
0F/1F Terra bianco  
Trasparente/Fumè

### in nicchia

IT-6/8/10/225

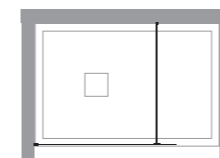

### niche

IT-6+B-6

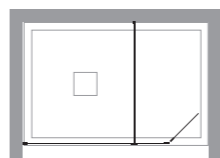

IT-8+B-6

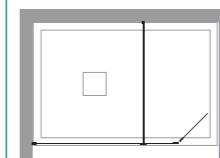

### ad angolo

IT-6/8/10/225

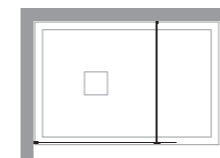

### corner

IT-6+B-6

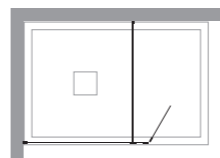

IT-8+B-6

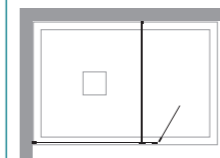

IT-6+L-6

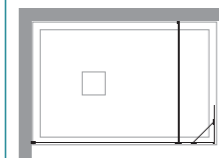

IT-6+IT-6

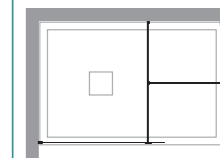

IT-8+IT-8

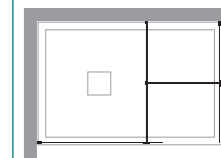

### ad angolo

IT-10+IT-10

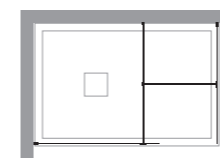

### corner

IT-225+IT-225

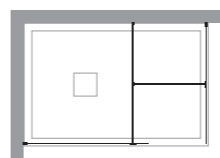

IT-6+IT-6+B-6

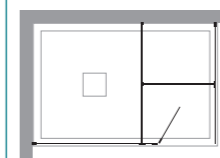

IT-8+IT-8+B-6

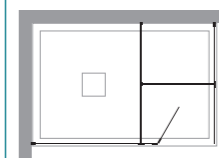

L-6+IT-6

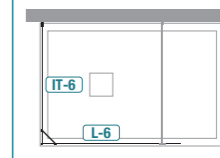

L-6+IT-6+IT-6

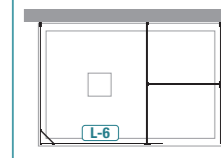

### centrale

IT-C6/C8/C10/C225

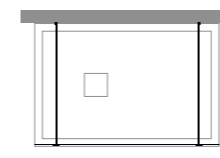

### central

IT-C8+B-6

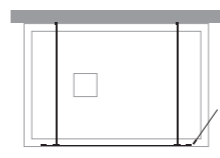

IT-C8+B-6+B-6

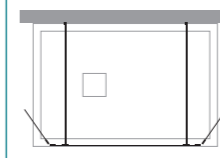

### installazioni particolari special installations

### importante

per installazioni particolari richiedere fattibilità all'ufficio tecnico TDA. Alcune configurazioni necessitano di elementi aggiuntivi

contact TDA technical office for particular installation. More elements could be needed

### important

ordini per pareti doccia speciali inoltrati senza relativo disegno **NON** vengono prodotti

orders for special shower walls forwarded without related design are **NOT** produced