





WALK-IN



ITALO



système de support assorti pour les combinaisons d'angle
charnières de déflecteur Bella avec rotation à 180°

*kombinierbar Unterstützungssystem für Eckkombinationen
Bella Deflektorscharniere mit 180° Drehung*





support de renfort fixe
profil au sol en finition

*feste Verstärkungsunterstützung
Bodenprofil im selben Finish*

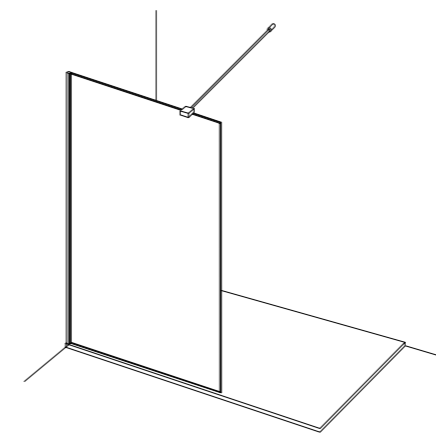

Walk-in montage latéral
Walk-in seitliche Montage

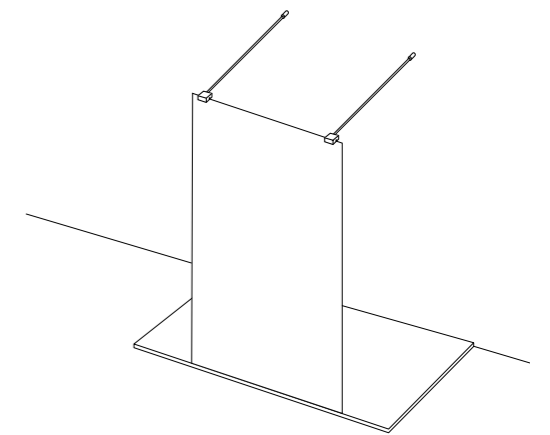

Walk-in montage central
Walk-in zentral Montage



CARACTÉRISTIQUES EIGENSCHAFTEN

H
cm HAUTEUR 200/225
HÖHE 200/225

SP
mm ÉPAISSEUR DU VERRE 6/8/10
GLASSTÄRKE 6/8/10

REV
RÉVERSIBLE
UMKEHRBAR

INFOS TECHNIQUES TECHNISCHE HINWEISE

REGLAGE DE FAUX APLOMB
SCHRÄGLAUF-EINSTELLUNG

1 cm
EXTENSIBILITÉ
DEHNBAR

NEVERDROP®
TRAITEMENT NEVERDROP®
NEVERDROP®

L/H
MESURES SPÉCIALES
SONDERMAßE

Finitions profilés

Fertigung der Profile

COLORE

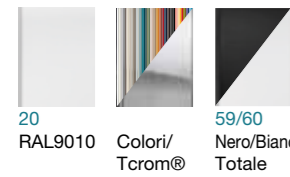

ABITAT



VOGUE

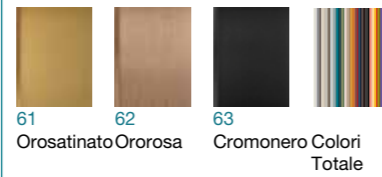

Verres

Glas

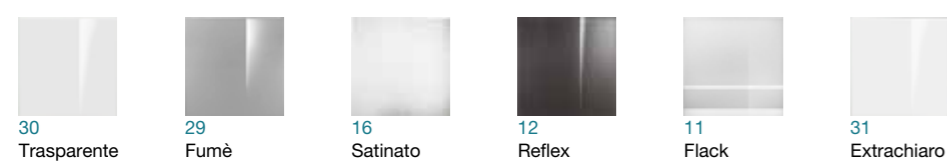

décographie

dekographie

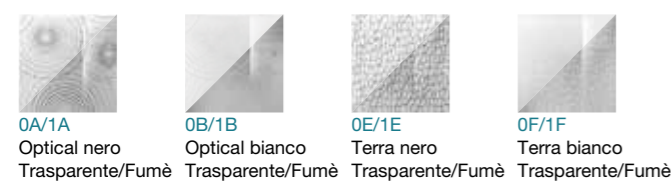

installations prévues Lösungen

en niche

IT-6/8/10/225

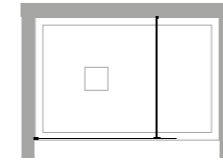

für Nische

IT-6+B-6

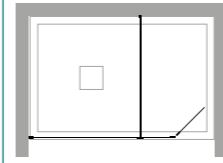

IT-8+B-6

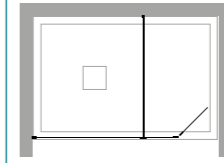

en angle

IT-6/8/10/225

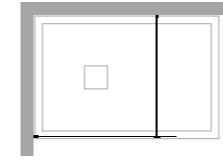

eckig

IT-6+B-6

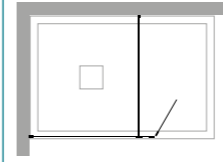

IT-8+B-6

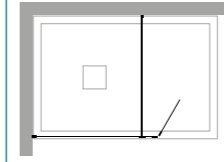

IT-6+L-6

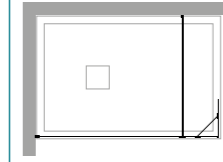

IT-6+IT-6

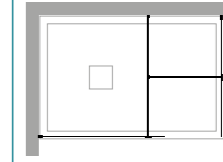

IT-8+IT-8

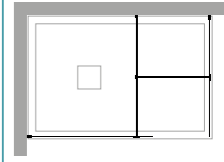

en angle

IT-10+IT-10

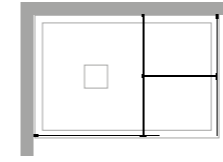

eckig

IT-225+IT-225

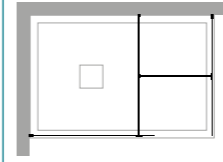

IT-6+IT-6+B-6

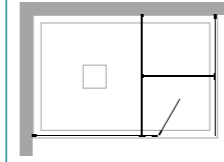

IT-8+IT-8+B-6

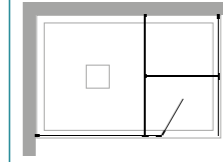

L-6+IT-6

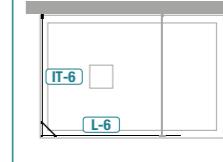

L-6+IT-6+IT-6

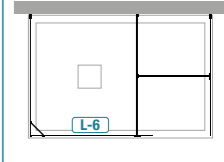

central

IT-C6/C8/C10/C225

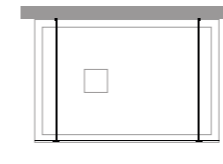

zentral

IT-C8+B-6

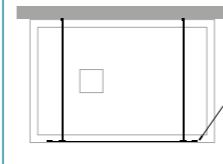

IT-C8+B-6+B-6

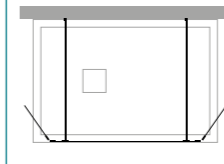

installations particulières

Sondern Lösungen

important

wichtig

Pour des installations particulières, demander la faisabilité au bureau technique TDA. Certaines configurations nécessitent des éléments supplémentaires

commandes spéciales pour paroi de douche transmises sans dessin **NE** sont pas produits

für besondere Lösungen seien Sie mit dem technischen Büro TDA in Verbindung

Besondere Duschwände werden ohne Zeichnung **NICHT** erstellt