

## Caratteristiche tecniche Technical features

Sistema modulare di contenitori ed elementi a giorno per la lavanderia. L'apertura di tutti i frontali avviene con la maniglia di serie modello Font in finitura cromo lucido. I contenitori sono disponibili con due aperture: anta a battente e doppio cassetto estraibile

Modular system of cabinets and open faced units for laundry. All the front panels are opened with the handle FONT in polished chrome finish. The cabinets are available with door or double drawer

## Caractéristiques techniques Technische Eigenschaften

Système modulaire de meubles et compartiments ouverts pour la buanderie. Toutes les devantes sont ouvertes par la poignée FONT en finition chrome poli. Les meubles sont disponibles avec porte ou double tiroir

Modulares System von Möbel und Regalschränke für Wäscherei. Alle die Frontteile werden mit dem Griff FONT in poliertem Chrom-Finish geöffnet. Die Schränke sind mit Tür oder Doppelschublade erhältlich



**AUDACE**

### Piano / Top / Plan / Platte

Piano squadrato realizzabile in diversi materiali e finiture  
TIPOLOGIE: piani arredo; piani per lavabo soprapiano da incasso e filopiano integrato  
PROFONDITA': 50-65 cm  
FINITURE: Nobilitato LEGNO - Nobilitato ALTATTO - Laccato OPACO/LUCIDO - CRISTALLO extrachiaro verniciato - HPL - GRES - SILESTONE® - PIETRA NATURALE - CASTMARBLE® - TECNORIL®

Squared top available in different materials and finishes  
TYPES: tops for interior; tops for recessed basin and integrated basin  
DEPTH: 50-65 cm  
FINISHES: Nobilitato LEGNO - Nobilitato ALTATTO - MATT/GLOSSY Lacquered - extra-clear lacquered GLASS - HPL - GRES - SILESTONE® - NATURAL STONE - CASTMARBLE® - TECNORIL®

Plan carré disponible en différents matériaux et finitions  
TYPES: plans pour l'ameublement; plans pour lavabo encastré surélevé et vasque intégrée  
PROFONDEUR: 50-65 cm  
FINITIONS: Nobilitato LEGNO - Nobilitato ALTATTO - Laqué MAT/BRILLANT - VERRE lacquée extraclair - HPL - GRES - SILESTONE® - PIERRE NATUELLE - CASTMARBLE® - TECNORIL®

Platte in verschiedenen Materialien und Ausführungen erhältlich  
TYPEN: platten fuer Einrichtung; platten fuer Halbeinbaubecken und integrierten Becken  
TIEFE: 50-65 cm  
OBERFLÄCHEN: Nobilitato LEGNO - Nobilitato ALTATTO - MATT/HOCHGLANZ Lackiert - Hochglanz lackierte GLAS - HPL - GRES - SILESTONE® - NATURSTEIN - CASTMARBLE® - TECNORIL®

### Apertura / Opening system / Système d'ouverture / Öffnungssystem

Maniglia modello Font L 16 e 32 cm. Installazione su ante e frontali in posizioni predefinite  
FINITURE: cromo lucido

Handle FONT L 16 and 32 cm. Installation on doors and drawers  
FINISHES: cromo lucido

Poignée FONT L 16 et 32 cm. Installation sur les portes et les tiroirs  
FINITIONS: cromo lucido

Griff FONT L 16 und 32 cm. Montage an Türen und Schbladen  
OBERFLÄCHEN: cromo lucido

### Contenitore / Cabinet / Meuble / Möbel

Realizzato in pannelli di particelle di legno di spessore 18 mm, idrofughi, nobilitato con carta melaminica colore URBAN. Bordi in ABS in tinta  
ALTEZZA: 56-76-88 cm  
PROFONDITA': 50-65 cm  
LARGHEZZA: 35-45-50-60-70-90 cm  
Zoccolo H 12 cm in PVC

Made of water repellent panels of 18 mm thick wood particles. Covered with Nobilitato URBAN color. Matching ABS edges  
HEIGHT: 56-76-88 cm  
DEPTH: 50-65 cm  
WIDTH: 35-45-50-60-70-90 cm  
Toe-kick H 12 cm in PVC

En panneaux hydrofuges en particules de bois de 18 mm d'épaisseur. Recouvert de papier mélaminé couleur URBAN. Bords ABS de la même couleur  
HAUTEUR: 56-76-88 cm  
PROFONDEUR: 50-65 cm  
LARGEUR: 35-45-50-60-70-90 cm  
Socle H 12 cm en PVC

In wasserabweisenden Platten aus 18 mm starken Holzpartikeln. Farbmelaminpapier und ABS Kanten der gleichen Farbe  
HÖHE: 56-76-88 cm  
TIEFE: 50-65 cm  
BREITE: 35-45-50-60-70-90 cm  
Sockel H 12 cm aus PVC

### Cassetti / Drawers / Tiroirs / Schubladen

Sistema GRASS® con sponde laterali in metallo verniciato colore URBAN. Fondo nobilitato finitura contenitore

GRASS® system with sides in painted metal and interior URBAN color

Système GRASS avec panneaux latéraux en métal et intérieur en Nobilitato couleur URBAN

GRASS®-System mit Seitengittern aus Metall und Innenausstattung in Nobilitato URBAN-farbig

### Allestimento interno / Interior configuration / Configuration intérieure / Innenausstattung

Ripiano in legno o cassetto estraibile con sponde laterali in metallo colore URBAN. Schienale in nobilitato finitura contenitore

Wood shelf or drawer with URBAN colored metal sides

Étagère en bois ou tiroir avec côtés en métal de couleur URBAN

Regal oder Schublade mit URBAN farbigen Metallseiten

### Ante e frontali / Doors and front panels / Portes et devant de tiroirs / Türen und Schubladefronten

Realizzati in pannelli di particelle di legno, idrofughi, nobilitati con carta melaminica  
SPESSORE: 1,8 cm  
FINISHES: colori TDA Laccato OPACO/LUCIDO - Nobilitato LEGNO

Made of water repellent panels of wood particles. Eennobled with melamine paper  
THICKNESS: 1,8 cm  
FINISHES: MATT/GLOSSY Lacquered colours TDA - Nobilitato LEGNO

En panneaux hydrofuges en particules de bois. Recouvert de papier mélaminé  
ÉPAISSEUR: 1,8 cm  
FINITIONS: couleurs TDA Laqué MAT/BRILLANT - Nobilitato LEGNO

Hergestellt aus wasserabweisenden Spanplatten, veredelt mit Melaminpapier  
DICKE: 1,8 cm  
OBERFLÄCHEN: farben TDA MATT/HOCHGLANZ Lackiert - Nobilitato LEGNO

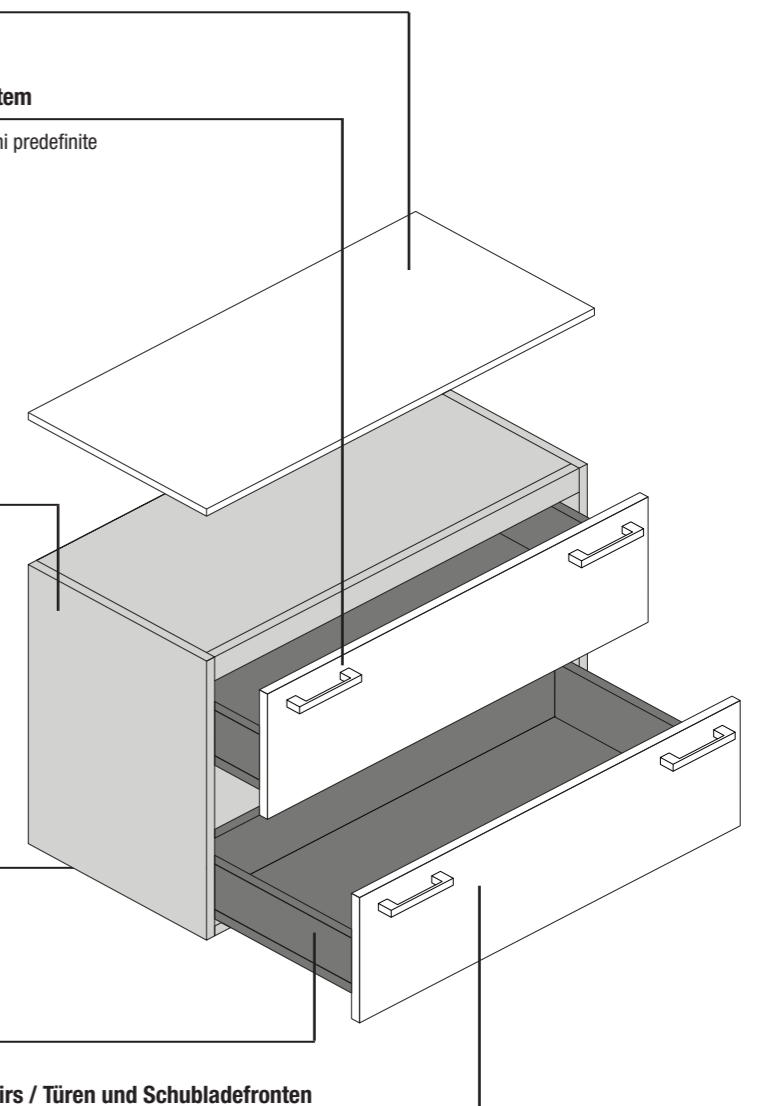

AUDACE

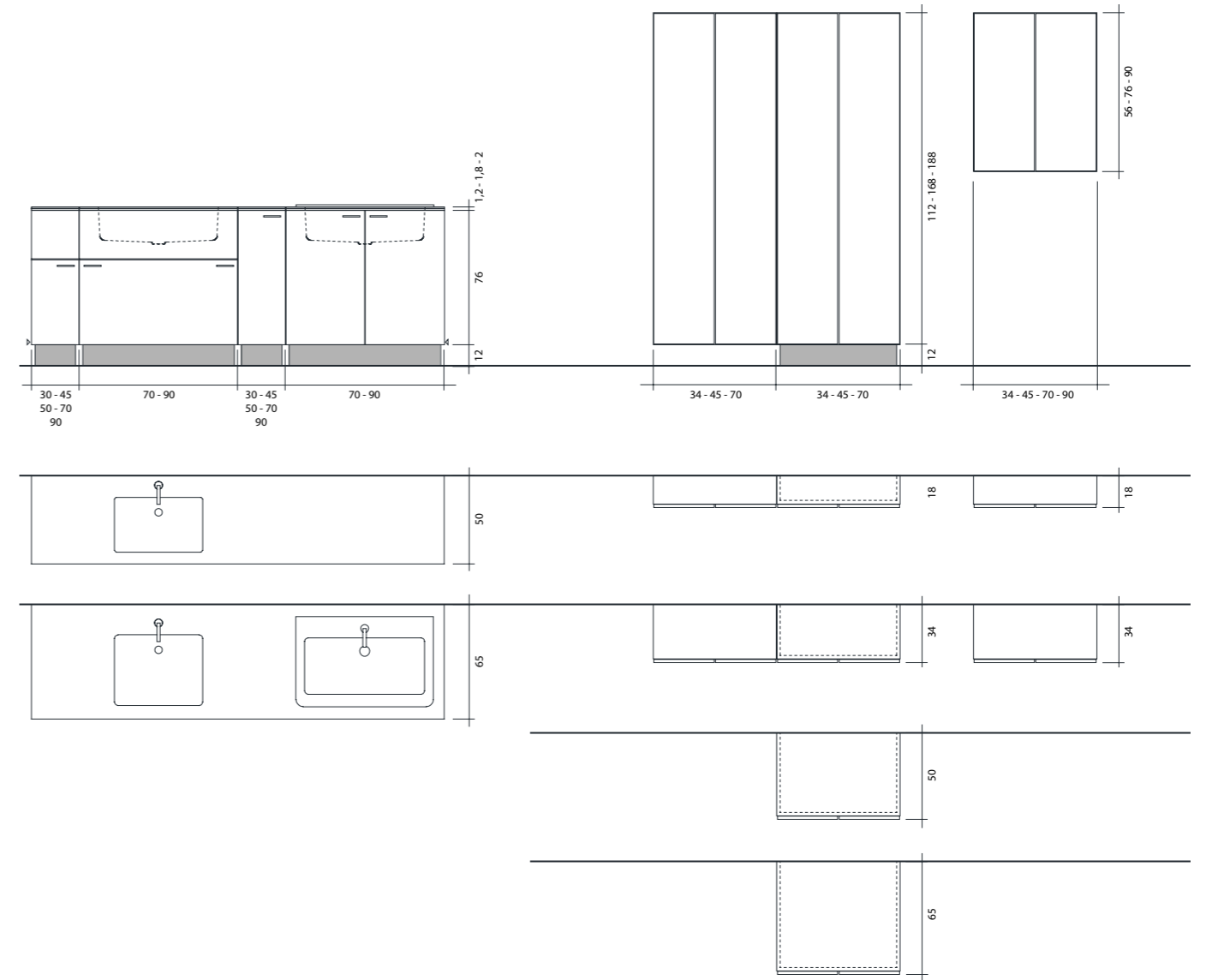
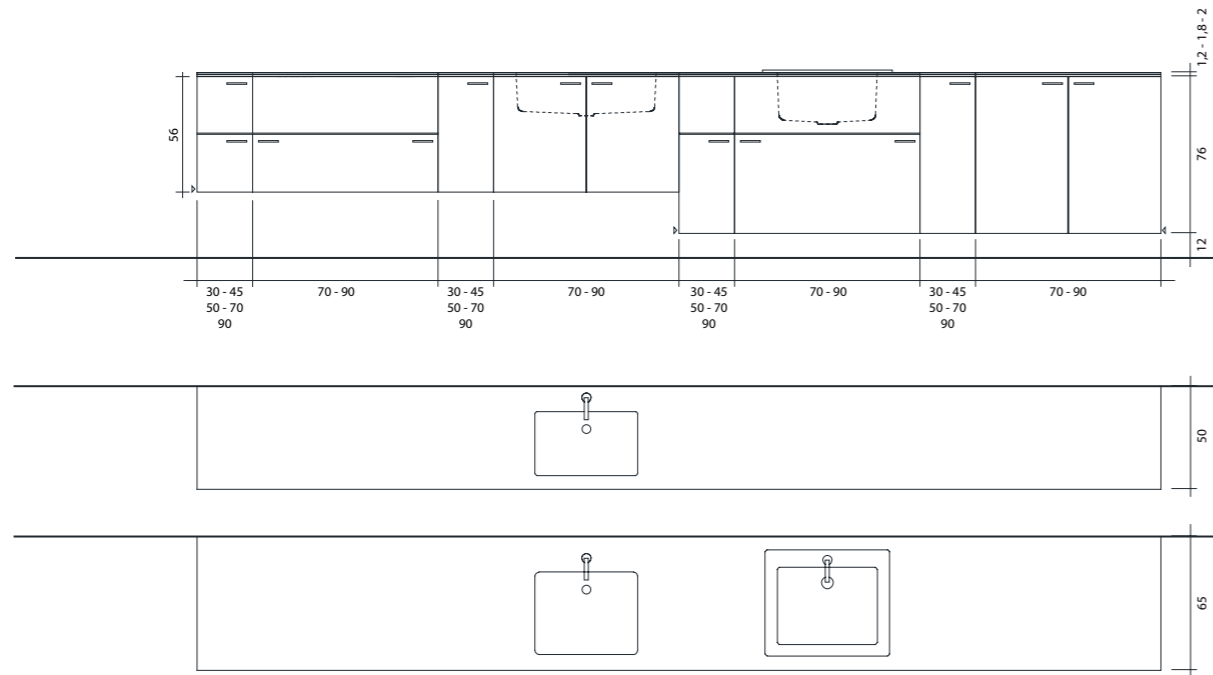

**Caratteristiche tecniche**  
**Technical features**

**Caractéristiques techniques**  
**Technische Eigenschaften**

**Modularità**  
**Modularity**

**basi portalavabo**  
**base units for washbasin**  
**meubles sous-vasque**  
**Waschtischunterschranke**

L 70-90 cm

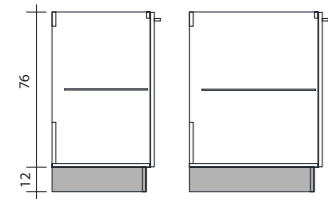
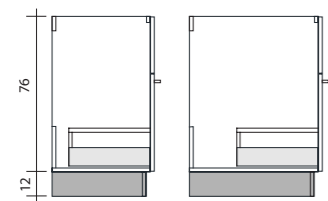
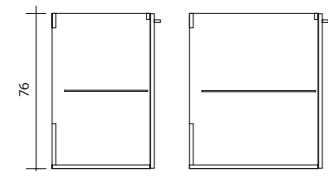
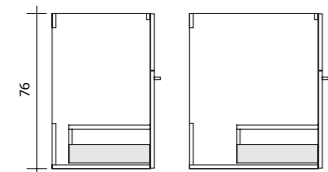
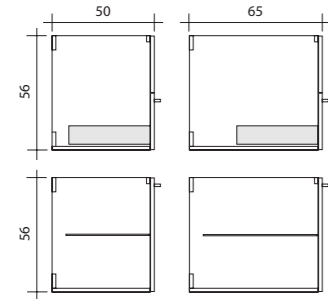

**Modularité**  
**Modularität**

**basi laterali**  
**side base units**  
**meubles bas latéraux**  
**Unterschranke**

L 35-45-50-70-90 cm

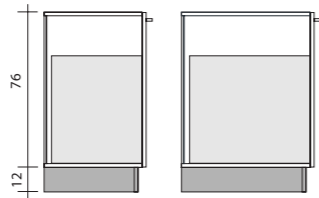
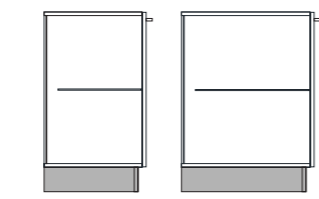
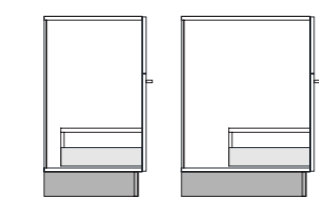
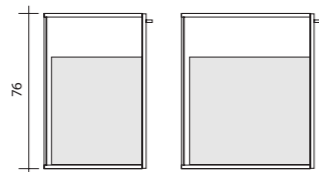
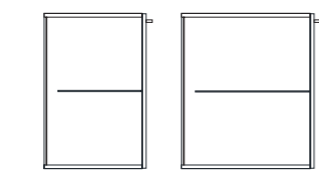
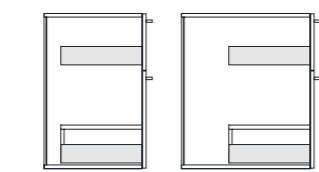
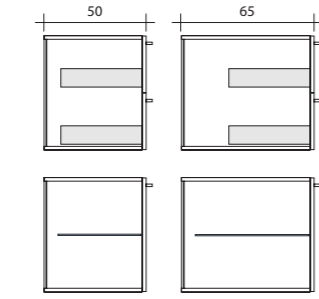

frontale fisso + frontale estraibile con cassetto / 2 frontali estraibili con cassetto  
fixed front + 1 removable fronts with drawer / 2 removable fronts with drawer  
fixe façade + 1 façade amovible avec tiroir / 2 façades amovibles avec tiroir  
fest Fassade + 1 Schublade / 2 Schublade

1 anta o 2 ante a battente + 1 ripiano  
1 door or 2 doors + 1 shelf  
1 porte ou 2 portes + 1 étagère  
1 Tür oder 2 Türen + 1 Regal

frontale fisso + frontale estraibile con cassetto / 2 frontali estraibili con cassetto  
fixed front + 1 removable fronts with drawer / 2 removable fronts with drawer  
fixe façade + 1 façade amovible avec tiroir / 2 façades amovibles avec tiroir  
fest Fassade + 1 Schublade / 2 Schublade

1 anta o 2 ante a battente + 1 ripiano  
1 door or 2 doors + 1 shelf  
1 porte ou 2 portes + 1 étagère  
1 Tür oder 2 Türen + 1 Regal

1 anta a ribalta  
1 flap door  
1 porte rabattable  
1 Klapptür

frontale fisso + frontale estraibile con cassetto / 2 frontali estraibili con cassetto  
fixed front + 1 removable fronts with drawer / 2 removable fronts with drawer  
fixe façade + 1 façade amovible avec tiroir / 2 façades amovibles avec tiroir  
fest Fassade + 1 Schublade / 2 Schublade

1 anta o 2 ante a battente + 1 ripiano  
1 door or 2 doors + 1 shelf  
1 porte ou 2 portes + 1 étagère  
1 Tür oder 2 Türen + 1 Regal

1 anta a ribalta  
1 flap door  
1 porte rabattable  
1 Klapptür

**Modularità**  
**Modularity**

**pensili**  
**wall units**  
**éléments hauts**  
**Hängeschränke**

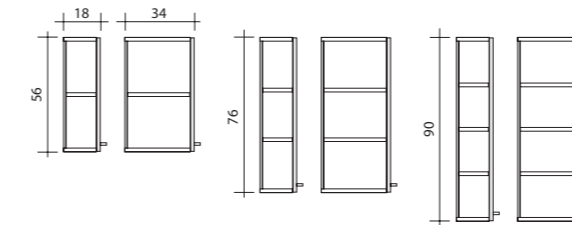

L 30-45 cm  
1 anta  
1 door  
1 porte  
1 Tür

L 70-90 cm  
2 ante  
2 doors  
2 portes  
2 Türen

**colonne**  
**tall cabinets**  
**colonnes**  
**Hochschränke**

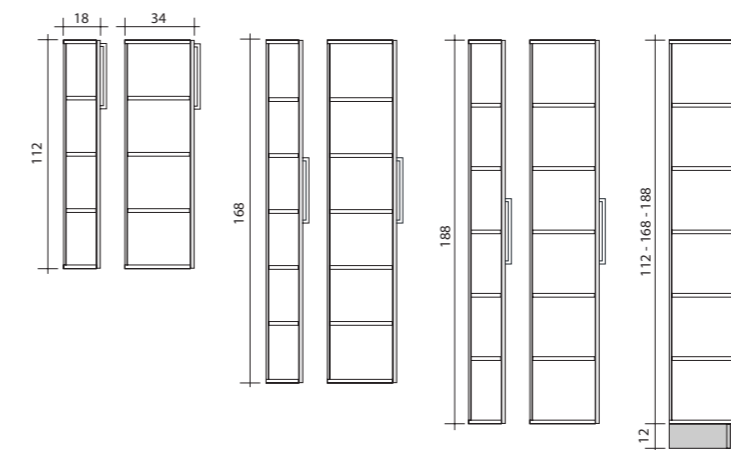

L 30-45 cm  
1 anta  
1 door  
1 porte  
1 Tür

L 70-90 cm  
2 ante  
2 doors  
2 portes  
2 Türen

L 30-45 cm  
1 anta  
1 door  
1 porte  
1 Tür

L 70-90 cm  
2 ante  
2 doors  
2 portes  
2 Türen

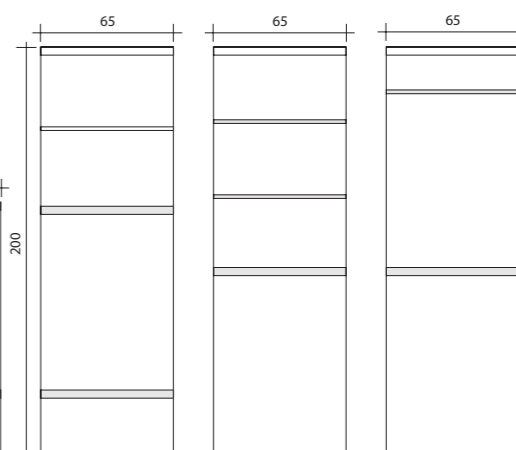

**elementi a giorno**  
**open-fronted elements**  
**éléments ouverts**  
**Offenen Elementen**

L 70-140 cm  
panche / bench / banquette / Bank

L da 60 a 220 cm  
banconi / work bench / banc de travail / Arbeitsplat

L 70 cm  
colonne a giorno / open column / colonne ouverte / Offene Hochschrank

**specchi e specchi contenitori**  
**mirror and mirror cabinet**  
**miroirs et armoire de toilette avec miroir**  
**Spiegel und Spiegelschranke**

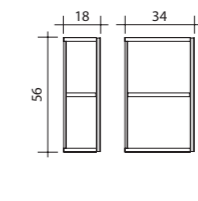
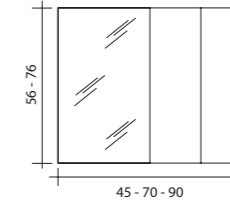

L 30-45 cm  
1 anta a specchio  
1 mirror door  
1 porte miroir  
1 Tür Spiegel

L 70-90 cm  
2 ante a specchio  
2 mirror doors  
2 portes miroir  
2 Türen Spiegel

**carrello portabiancheria**  
**laundry trolley**  
**chariot pour ligne**  
**Wäschewagen unter Waschtisch**

L 45-60 cm

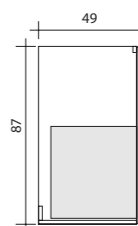

# Caratteristiche tecniche Technical features

# Caractéristiques techniques Technische Eigenschaften

## Modularità Modularity

## Modularité Modularität

colonne attrezzate  
columns  
colonnes  
Hochschränke



colonne per ripostiglio  
storage columns  
colonnes pour rangement  
Stauraum

L 45 cm	L 70 cm
1 anta	2 ante
1 door	2 doors
1 porte	2 portes
1 Tür	2 Türen

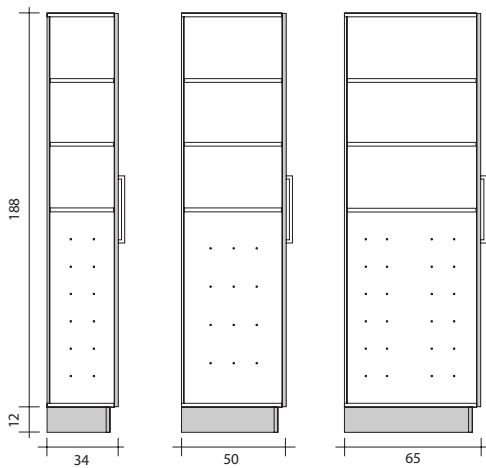

colonne per scarpiera  
shoe columns  
colonnes pour chassures  
Schuhschranke

L 45 cm	L 70 cm
1 anta	2 ante
1 door	2 doors
1 porte	2 portes
1 Tür	2 Türen

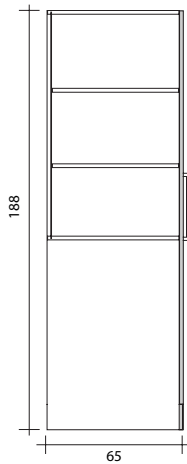

colonne per lavatrice  
columns for washing machine  
colonnes pour machine à laver  
Hochschränke für Waschmaschine

L 70 cm  
2 ante  
2 doors  
2 portes  
2 Türen

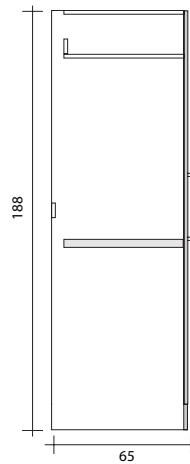

colonne per lavatrice e asciugatrice  
columns for washing machine and drier  
colonnes pour machine à laver et sèche-linge  
Hochschränke für Waschmaschine und Trockner

L 70 cm  
2 ante  
2 doors  
2 portes  
2 Türen